

Sterimedix[®]
ophthalmic

EXPERTISE

in single-use ophthalmic surgical products

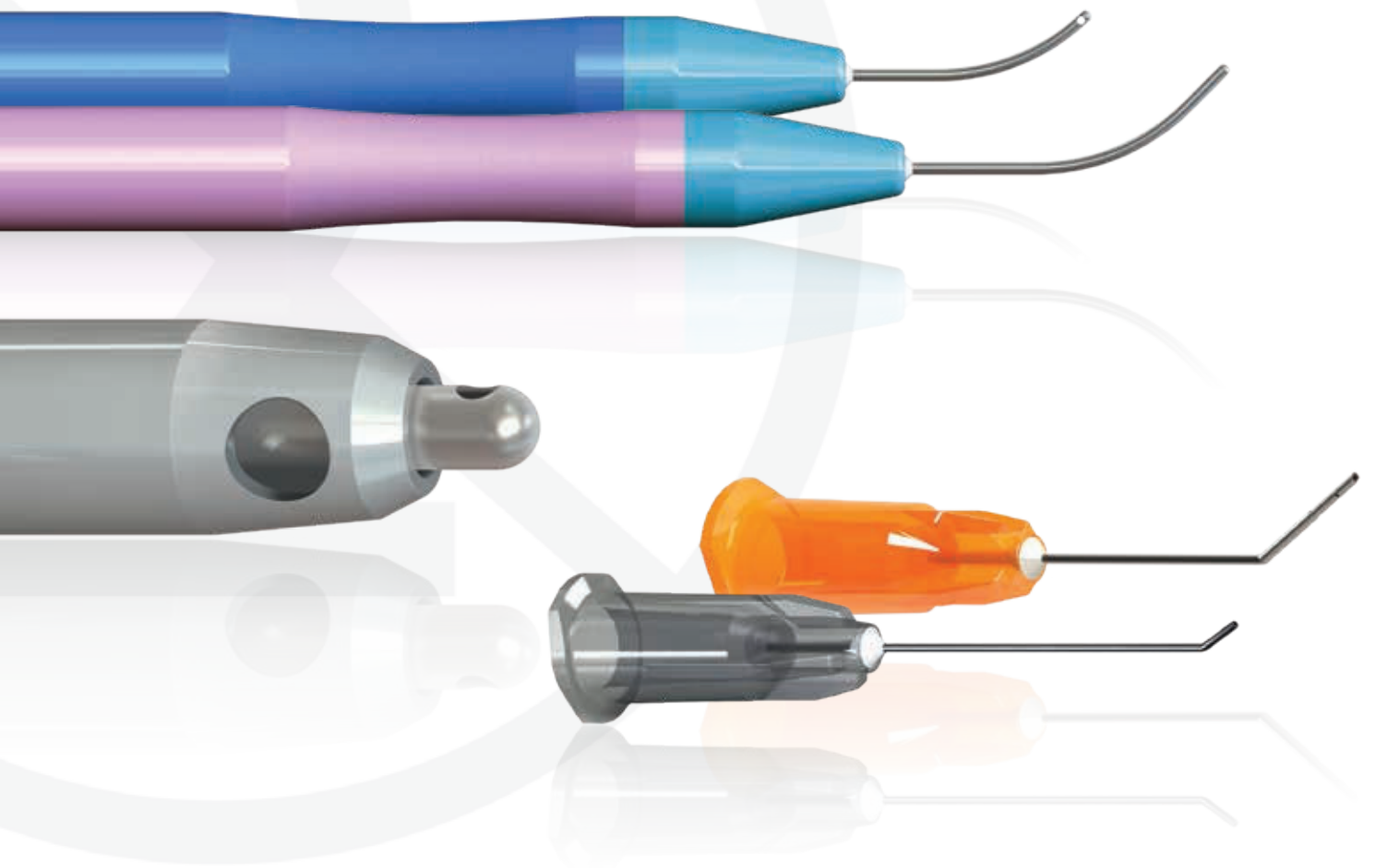

www.sterimedix.com

Sterimedix[®]

ophthalmic

Consistency in a Changing World

manufacturing single-use ophthalmic cannulas and handpieces

With over 30 years' experience as a manufacturer of single use ophthalmic surgical products, Sterimedix is now the leading European manufacturer of single use ophthalmic cannulas.

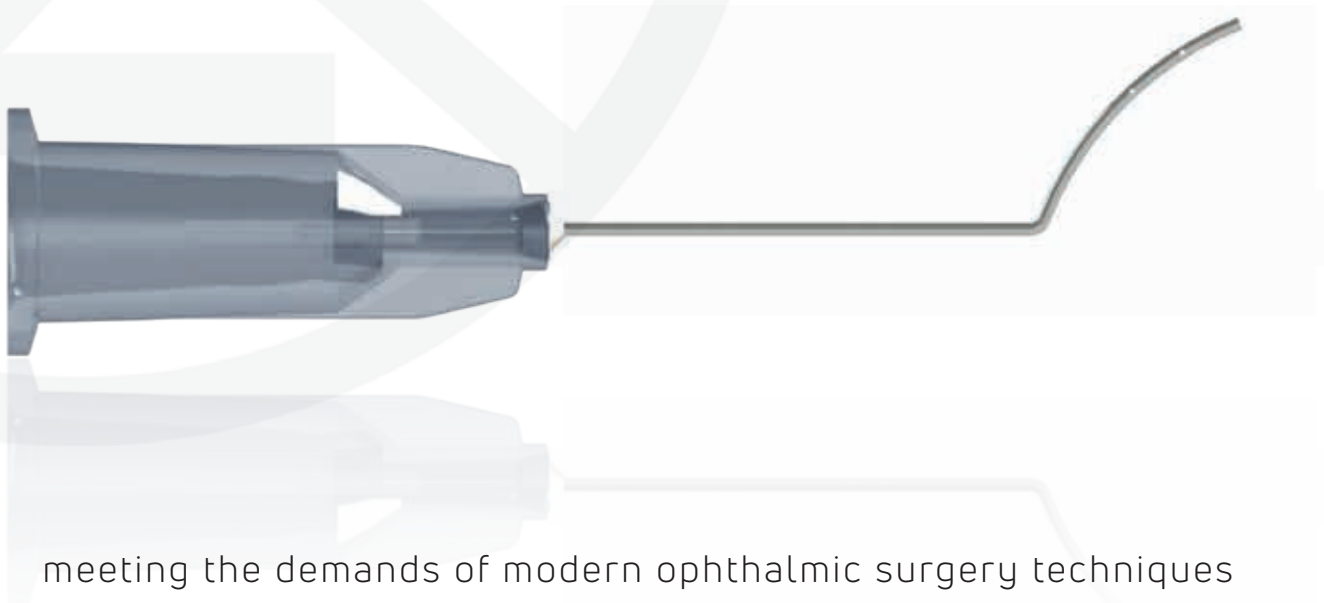

meeting the demands of modern ophthalmic surgery techniques



Index

PAGE

4	Refractive Cannulas
4	Scleral Markers
5	Anaesthesia Needles & Cannulas
6	Anterior Chamber Cannulas & Maintainers
6	Transzonular Injection Cannula
7	Viscoelastic Cannulas
8	Cystotomes
10	Hydrodissection Cannulas
11	Hydrodelineation Cannulas
11	Cortical Cleaving Cannulas
11	Viscoexpression Cannulas
12	Nucleus Removal Cannulas
12	Cortex Removal Cannulas
13	Capsule Polishing Cannulas
14	Irrigating / Aspirating Cannulas and Handpieces
15	Simcoe Irrigating / Aspirating Cannulas
16	Bimanual Irrigating / Aspirating Cannulas and Handpieces
17	Bimanual I/A Systems
18	Lachrymal Cannulas
19	Trocar Sets
20	Vitreoretinal Cannulas
21	Vitreoretinal Soft Tips & Brushes
22	Backflush Handles & Combination Sets
23	Heavy Liquid Infusion Handles
23	Charles Flute Handles & Combination Sets
23	Information for Kit Packers
24	Product Index



Products are supplied in different formats to meet the needs of our customers:

- ▶ Packed sterile in convenient box quantities of either 5, 10 or 100.
- ▶ Packed sterile in bulk for our industry partners
- ▶ Packed non-sterile, in bulk for kit packers.
Most non-sterile products are packed in a protective sheath labelled with the product code & LOT number.















QUALITY ASSURANCE

Sterimedix Limited is committed to producing medical devices to the highest possible quality. The Company's Quality Management System is accredited to ISO 13485:2016. Our products are CE marked, registered with the United States FDA and have appropriate approvals in all other markets where Sterimedix is active.

Refractive Cannulas / Scleral Markers

Refractive Cannulas

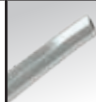

For irrigating either the anterior or posterior sides of the flap and the stroma in laser refractive procedures.

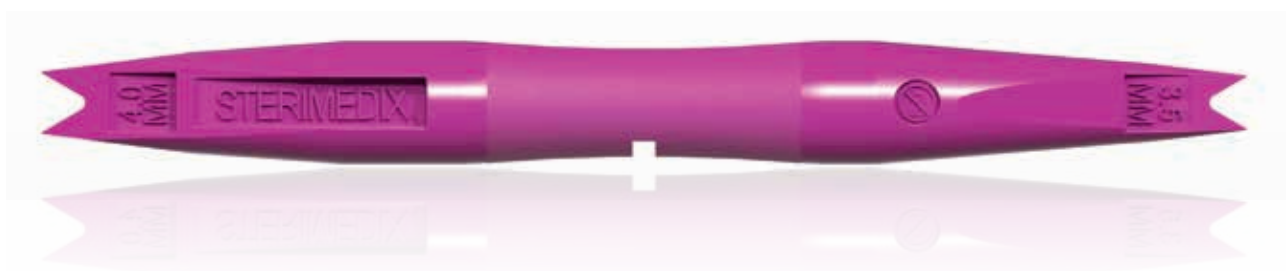
Model	Gauge	Image	Dimensions	Description	Ports	Image	BOX	
							10	100
M2804	25 G		25 G x 7/8" 0.5 x 22mm	Irrigating lasik cannula. Formed 7mm from tip	6 x 0.15mm ports at 2, 4 and 6mm from tip		10	100
M2817	27 G		27 G x 7/8" 0.4 x 22mm	Irrigating lasik cannula. Formed 9mm from tip	4 x 0.15mm ports at 2 and 4mm from tip		10	100
M2822	25 G		25 G x 7/8" 0.5 x 22mm	Irrigating lasik cannula. Formed 7mm from tip	6 x 0.15mm ports at 2, 4 and 6mm from closed tip		10	100
M2824	26 G		26 G x 7/8" 0.45 x 22mm	Irrigating lasik cannula. Formed 9.5mm from tip. (Slade)	Spatulated tip		10	100
M2801	25 G		25 G x 7/8" 0.5 x 22mm	Irrigating lasik cannula. Angled. (Lin)	Flattened tip 2 x 0.25mm ports		10	100
M2802	25 G		25 G x 1 1/8" 0.5 x 29mm	Irrigating lasik cannula. Formed. (Buratto)	2 x 0.2mm ports		10	100
M3914	23 G		23 G x 7/8" 0.64 x 22mm	Irrigating lasik cannula. Formed 10.5mm from tip	Flattened tip		10	100



Scleral Markers (Sterile and Non Sterile)

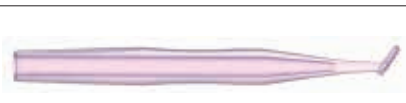



Used to mark the point for any pars plana incision or injection point

Model	Image	Dimensions	Description	Image	BOX
					10
M7500		3.5mm / 4.0mm	Scleral marker. 80mm long		10
M7510		3.5mm	Scleral fixation plate. 75mm long		10

Anaesthetic Cannulas and Needles

















Anaesthetic Cannulas

For administering anaesthetic into the sub tenon space.

Code	Gauge	Image	Dimensions	Description	Tip	BOX	
						10	100
M0278	19 G		19 G x 1" 1.1 x 25mm	Sub tenon cannula. Curved	Flattened tip		10 100
M0279	20 G		20 G x 1" 0.9 x 25mm	Sub tenon cannula. Curved	Flattened tip		10 100

Anaesthetic Needles





For administering anaesthetic around the globe.

Code	Gauge	Image	Dimensions	Description	Tip	BOX	
						10	100
M0275	25 G		25 G x 1 1/2" 0.5 x 38mm	Retrobulbar. Tri-facet		10 100	
M0637	25 G		25 G x 1 1/2" 0.5 x 38mm	Retrobulbar (Atkinson)		10 100	
M0638	23 G		23 G x 1 1/2" 0.64 x 38mm	Retrobulbar (Atkinson)		10 100	
M0641A	27 G		27 G x 1 1/4" 0.4 x 32mm	Peribulbar (Atkinson)		10 100	
M0642	25 G		25 G x 1 1/4" 0.5 x 32mm	Peribulbar (Atkinson)		10 100	
M0643	23 G		23 G x 1 1/4" 0.64 x 32mm	Peribulbar (Atkinson)		10 100	
M0641	27 G		27 G x 7/8" 0.4 x 22mm	Peribulbar (Atkinson)		10 100	
M0642A	25 G		25 G x 7/8" 0.5 x 22mm	Peribulbar (Atkinson)		10 100	

Anterior Chamber Maintenance

























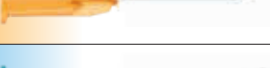

Anterior Chamber Maintainers

Self retaining cannulas for maintaining and forming the anterior or posterior chamber by infusing or aspirating balanced salt solution (BSS), air, or viscoelastic.

M2658	23 G		23 G x 3/64" 0.64 x 3.5mm	Anterior chamber maintainer. 150mm silicone tubing. Annular rings allow cannula to be self retaining (Lewicky)		BOX	
						10	
M2657	20 G		20 G x 3/64" 0.64 x 3.5mm	Anterior chamber maintainer. 150mm silicone tubing. Annular rings allow cannula to be self retaining (Lewicky)		BOX	
						10	

Anterior Chamber Maintenance Cannulas

For maintaining and forming the anterior or posterior chamber by infusing or aspirating balanced salt solution (BSS), air, or viscoelastic.

							BOX	
M2280	27 G		27 G x 7/8" 0.4 x 22mm	Transzonular injection cannula. Angled	Angled 33°, 2mm from tip		10	100
M2639	25 G		25 G x 1" 0.5 x 25mm	Anterior chamber cannula. Angled. (Rycroft)	Angled 35°, 7.5mm from tip		10	100
M2270	30 G		30 G x 7/8" 0.3 x 22mm	Anterior chamber cannula. Angled. (Rycroft)	Angled 35°, 4mm from tip		10	100
M2270A	30 G		30 G x 7/8" 0.3 x 22mm	Anterior chamber cannula. Angled (Rycroft)	Angled 35°, 8mm from tip		10	100
M2273	30 G		30 G x 7/8" 0.3 x 22mm	Anterior chamber cannula. Angled. (Rycroft)	Angled 35°, 5.5mm from tip		10	100
M2273A	27 G		27 G x 7/8" 0.4 x 22mm	Anterior chamber cannula. Angled. (Rycroft)	Angled 35°, 4.5mm from tip		10	100
M2279	27 G		27 G x 7/8" 0.4 x 22mm	Anterior chamber cannula. Angled. (Rycroft)	Angled 45°, 11mm from tip		10	100
M2275	25 G		25 G x 7/8" 0.5 x 22mm	Anterior chamber cannula. Angled. (Rycroft)	Angled 35°, 5mm from tip		10	100
M2273G	23 G		23 G x 7/8" 0.64 x 22mm	Anterior chamber cannula. Angled. (Rycroft)	Angled 35°, 5.5mm from tip		10	100
M2642	21 G		21 G x 7/8" 0.81 x 22mm	Anterior chamber cannula. Angled. (Rycroft)	Angled 35°, 7.5mm from tip		10	100
M2273B	20 G		20 G x 7/8" 0.9 x 22mm	Anterior chamber cannula. Angled. (Rycroft)	Angled 45°, 7.5mm from tip		10	100
M9280	19 G		19 G x 1" 1.1 x 25mm	Washout cannula. Angled. (Bishop Harmon)	Angled 32°, 8mm from tip. Tip flattened in the horizontal plane		10	100
M9281	16 G		16 G x 1" 1.6 x 25mm	Washout cannula. Angled	Angled 30°, 6.5mm from the tip. Tip flattened in the horizontal plane		10	100

Viscoelastic Cannulas

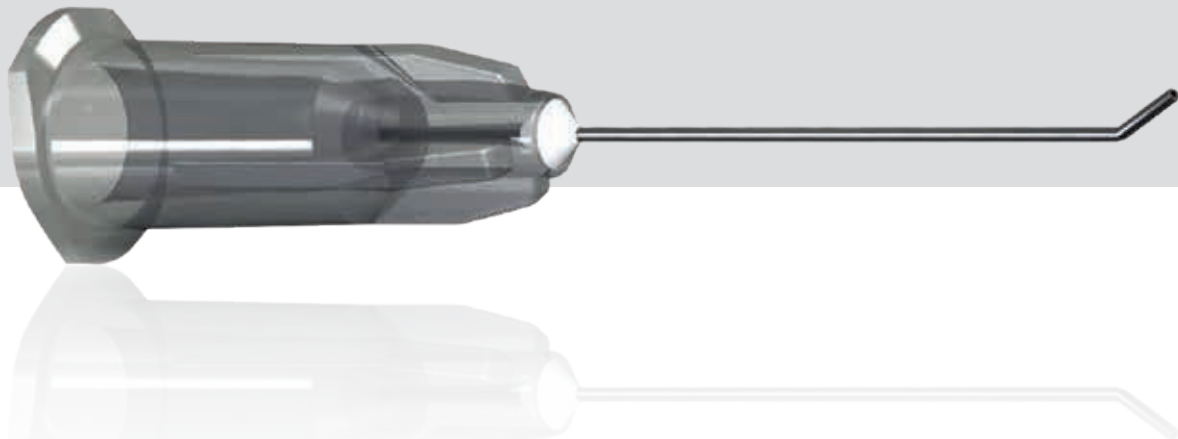

Viscoelastic Cannulas

For maintaining and forming the anterior or posterior chamber by infusing or aspirating viscoelastic.

Model	Gauge	Image	Dimensions	Description	Angle	Tip Distance	BOX	
							10	100
M3926A	27 G		27 G x 7/8" 0.4 x 22mm	Viscoelastic cannula. Angled	Angled 35°	9mm from tip	10	100
M3927	27 G		27 G x 7/8" 0.4 x 22mm	Viscoelastic cannula. Angled	Angled 25°	8mm from tip	10	100
M2272	26 G		26 G x 7/8" 0.45 x 22mm	Viscoelastic cannula. Angled	Angled 35°	9mm from tip	10	100
M2639A	25 G		25 G x 7/8" 0.5 x 22mm	Viscoelastic cannula. Angled	Angled 35°	9mm from tip	10	100
M3909	23 G		23 G x 7/8" 0.64 x 22mm	Viscoelastic cannula. Angled	Angled 45°	9mm from tip	10	100
M3910A	21 G		21 G x 7/8" 0.81 x 22mm	Viscoelastic cannula. Angled	Angled 45°	9mm from tip	10	100
M3910	21 G		21 G x 7/8" 0.81 x 22mm	Viscoelastic cannula.			10	100
M3917	27 G		27 G x 7/8" 0.4 x 22mm	Viscoelastic cannula. Angled and formed	Angled	and formed, 11mm from tip	10	100

Cystotomes

For capsularhexis, intercapsular, endocapsular, or can opening capsulotomies during cataract surgery.

Formed Irrigating Cystotomes

Model	Gauge	Image	Dimensions	Description	Special Features	Tip Image	BOX	
							10	100
M3630	30 G		30 G x 5/8" 0.3 x 16mm	Cystotome. Formed			10	100
M3610B	27 G		27 G x 5/8" 0.4 x 16mm	Cystotome. Formed			10	100
M3610	25 G		25 G x 5/8" 0.5 x 16mm	Cystotome. Formed			10	100
M3610S	25 G		25 G x 5/8" 0.5 x 16mm	Cystotome. Formed	Short tip		10	100
M3602	25 G		25 G x 5/8" 0.5 x 16mm	Cystotome. Formed	Side cutting		10	100
M3610C	25 G		25 G x 5/8" 0.5 x 16mm	Cystotome. Formed	Tip angled 35°		10	100
M3627A	27 G		27 G x 5/8" 0.4 x 16mm	Cystotome. Short curve. Formed			10	100
M3627	25 G		25 G x 5/8" 0.5 x 16mm	Cystotome. Short curve. Formed			10	100
M3626	27 G		27 G x 5/8" 0.4 x 16mm	Cystotome. Angled			10	100
M3626A	25 G		25 G x 5/8" 0.5 x 16mm	Cystotome. Angled			10	100
M3629	25 G		25 G x 5/8" 0.5 x 16mm	Cystotome. Formed	Reverse tip		10	100
M3615	27 G		27 G x 7/8" 0.4 x 22mm	Long cystotome. Formed			10	100

Cystotomes

For capsularhexis, intercapsular, endocapsular, or can opening capsulotomies during cataract surgery.

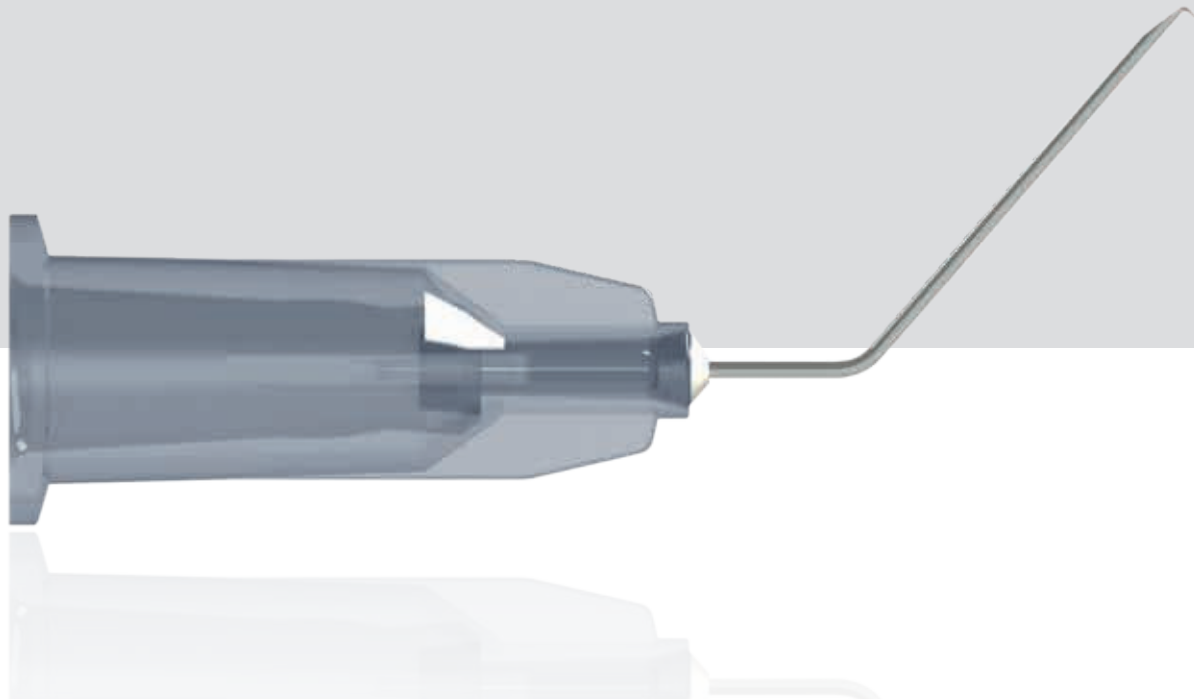

Formed Capsularhexis Cystotomes

Model	Gauge	Image	Dimensions	Description	Image	BOX	
						10	100
M3000F	27 G		27 G x 5/8" 0.4 x 16mm	Cystotome. Formed		10	100
M3000G	25 G		25 G x 5/8" 0.5 x 16mm	Cystotome. Formed		10	100
M3000E	27 G		27 G x 5/8" 0.4 x 16mm	Cystotome. Short curve. Formed		10	100
M3000D	25 G		25 G x 5/8" 0.5 x 16mm	Cystotome. Short curve. Formed		10	100

Formed Endocapsular Cystotome

Model	Gauge	Image	Dimensions	Description	Image	BOX	
						10	100
NEW M3001	27 G		27 G x 5/8" 0.4 x 16mm	Endocapsular cystotome. Formed. (Joyce)		10	100

Hydrodissection Cannulas

For delivering fluids to facilitate the separation of the cortex from the nucleus & capsule.











Hydrodissection Cannulas

Model	Gauge	Image	Dimensions	Type	Tip Description	Image	BOX	
							10	100
M3919	27 G		27 G x 7/8" 0.4 x 22mm	Hydrodissector. Angled. (Akahoshi)	2mm tapered tip		10	100
M2273C	27 G		27 G x 7/8" 0.4 x 22mm	Hydrodissector. Curved. (Sauter)	Tip flattened in vertical plane		10	100
M2273D	25 G		25 G x 7/8" 0.5 x 22mm	Hydrodissector. Curved. (Sauter)	Tip flattened in vertical plane		10	100
M2273E	27 G		27 G x 7/8" 0.4 x 22mm	Hydrodissector. Curved. (Helsinki)	Tip flattened in horizontal plane		10	100
M2273F	25 G		25 G x 7/8" 0.5 x 22mm	Hydrodissector. Curved. (Helsinki)	Tip flattened in horizontal plane		10	100
M2274	25 G		25 G x 7/8" 0.5 x 22mm	Hydrodissector. Curved. (Kellan)	Tip flattened in vertical plane		10	100
M3992	30 G		30 G x 7/8" 0.3 x 22mm	Hydrodissector. Angled	Angled 7mm from tip. Tip tapered and flattened in the horizontal plane		10	100
M3902	27 G		27 G x 7/8" 0.4 x 22mm	Hydrodissector. Angled	Angled 9mm from tip. Tip tapered and flattened in the horizontal plane		10	100
M3900	25 G		25 G x 7/8" 0.5 x 22mm	Hydrodissector. Angled	Angled 7mm from tip. Tip tapered and flattened in the horizontal plane		10	100
M2273H	27 G		27 G x 7/8" 0.4 x 22mm	Hydrodissector. Curved	Rounded tip		10	100







Hydrodissection / Hydrodelineation / Viscoexpression Cannulas

For delivering fluids to facilitate the separation of the cortex from the nucleus & capsule.





Hydrodissection Cannulas

Model	Gauge	Image	Dimensions	Type	Description	Image	BOX	
							10	100
M3904	27 G		27 G x 3/8" 0.4 x 19mm	Hydrodissector. (Chang)	Tip angled 90° and flattened in the vertical plane		10	100
M3912	23 G		23 G x 7/8" 0.64 x 22mm	Hydrodissector. Angled. (Mackool)	Angled 30° 8mm from tip. Flattened 4mm from tip. Tip flattened in horizontal plane		10	100
M3906A	25 G		25 G x 7/8" 0.5 x 22mm	Hydrodissector	Round tip, 1.75mm wide. J-shaped tip		10	100
NEW M3920	27 G		27 G x 7/8" 0.4 x 22mm	Hydrodissector. Curved. (Frankfurt)			10	100
NEW M3922	27 G		27 G x 7/8" 0.4 x 22mm	Hydrodissector. Formed. (Daya)	Tip flattened in horizontal plane		10	100





Cortical Cleaving Cannulas

Model	Gauge	Image	Dimensions	Type	Description	Image	BOX	
							10	100
M3908	25 G		25 G x 7/8" 0.5 x 22mm	Cortical cleaving hydrodissector. Angled	Tapered to 0.3mm at tip. Angled at 45°, 1mm from tip		10	100
M3911	27 G		27 G x 7/8" 0.4 x 22mm	Cortical cleaving hydrodissector. Angled	Angled at 45°, 11mm from tip. Flattened in horizontal plane 2.75mm from tip		10	100
M3911A	27 G		27 G x 7/8" 0.4 x 22mm	Cortical cleaving hydrodissector. Angled	Angled 45°, 11mm from round tip		10	100

Hydrodelineation Cannulas

Model	Gauge	Image	Dimensions	Type	Description	Image	BOX	
							10	100
M3907	25 G		25 G x 7/8" 0.5 x 22mm	Hydrodelineator	Tapered to 0.3mm at tip. Angled at 45°, 4.5mm from tip		10	100
NEW M3921	25 G		25 G x 7/8" 0.5 x 22mm	Hydrodelineator. Curved	Tapered to 0.3mm at tip		10	100





Viscoexpression Cannulas

Model	Gauge	Image	Dimensions	Type	Description	Image	BOX	
							10	100
M3899	25 G		25 G x 7/8" 0.5 x 22mm	Viscoexpression cannula	Flat tip angled 2mm from tip (Corydon)		10	100
M3899A	25 G		25 G x 7/8" 0.5 x 22mm	Viscoexpression cannula	Round tip angled 1.8mm from tip (Corydon)		10	100

Nucleus / Cortex Removal Cannulas















Nucleus Removal Cannulas

For the aspiration of cortex

Model	Gauge	Image	Dimensions	Description	Port Configuration	Image	BOX	
							10	100
M4619	25 G		25 G x 1 1/2" 0.5 x 38mm	Irrigating vectis	5mm wide. Single port		10	100
M4620	25 G		25 G x 1 1/2" 0.5 x 38mm	Irrigating vectis	5mm wide. Twin ports		10	100

Cortex Removal Cannulas









For either removing the nucleus, large fragments of the nucleus, large pieces of cortical debris, or aspirating cortical debris.

Model	Gauge	Image	Dimensions	Description	Port Configuration	Image	BOX	
							10	100
M6576	23 G		23 G x 7/8" 0.64 x 22mm	Cortex extractor. Curved	0.3mm top port		10	100
M6575	23 G		23 G x 5/8" 0.64 x 16mm	Cortex extractor. Curved	0.3mm top port		10	100
M6575A	23 G		23 G x 5/8" 0.64 x 16mm	Cortex extractor. Curved	0.4mm top port		10	100
NEW M6575B	23 G		23 G x 5/8" 0.64 x 16mm	Cortex extractor. Curved	0.3mm top port		10	100
M6576A	23 G		23 G x 5/8" 0.64 x 16mm	Cortex extractor. Curved	0.3mm top port		10	100
M6594	23 G		23 G x 5/8" 0.64 x 16mm	Cortex extractor. Curved. (Charleux)	0.3mm bevelled end port		10	100
M6596	24 G		24 G x 1/2" 0.56 x 12.5mm	Cortex extractor. Curved. (Charleux)	0.3mm bevelled end port		10	100
M6595	23 G		23 G x 1/2" 0.64 x 12.5mm	Cortex extractor. Curved. (Charleux)	0.3mm bevelled end port		10	100





Capsule Polishing Cannulas

Capsule Polishing Cannulas







For polishing and cleaning the residual cortex from the capsular bag. Silicone tipped polishers provide for gentle polishing and atraumatic insertion and removal. Micro etched tips are slightly roughened to facilitate gentle polishing.

Model	Gauge	Image	Specs	Description	Features	Image	BOX	
							10	100
M8604A	23 G		23 G x 7/8" 0.64 x 22mm	Capsule polisher. Angled	Angled 9mm from tip. Aspiration through 0.3mm side port. Micro-etched tip		10	100
M8604	21 G		21 G x 1" 0.81 x 25mm	Capsule polisher. Angled	Angled 12.5mm from tip. Aspiration through 0.3mm side port. Micro-etched tip		10	100
M8604B	21 G		21 G x 7/8" 0.81 x 22mm	Capsule polisher. Angled	Angled 9mm from tip. Aspiration through 0.3mm side port. Micro-etched tip.		10	100
M8645	23 G		23 G x 7/8" 0.64 x 22mm	Capsule scraper. Angled	Angled 0.5 & 7mm from tip. Micro-etched distal end.		10	100

Silicone Tipped Polishers

Model	Gauge	Image	Specs	Description	Image	BOX	
						10	100
M8605	27 G		27 G x 7/8" 0.4 x 22mm	Silicone tipped polisher. Angled		10	100
M8605A	23 G		23 G x 7/8" 0.64 x 22mm	Silicone tipped polisher. Angled		10	100



Olive Tipped Cannulas

Model	Gauge	Image	Specs	Description	Features	Image	BOX	
							10	100
M8622	25 G		25 G x 1" 0.5 x 25mm	Olive tipped polisher. Angled	Angled 10mm from tip. Micro-etched tip.		10	100
M8620C	23 G		23 G x 1" 0.64 x 25mm	Olive tipped polisher. Curved			10	100
M8621	23 G		23 G x 1" 0.64 x 25mm	Olive tipped polisher. Curved	Micro-etched tip		10	100





Irrigating/Aspirating Cannulas and Handpieces

For the aspiration of cortex while simultaneously maintaining the Anterior Chamber with continuous irrigating flow.

Coaxial Cannulas

M6611	21 G 	21 G x 1½" 0.81 x 38mm	I/A Straight Cannula		BOX	
					10	100



Coaxial Handpieces

						BOX
M5592	17/24G 	1.47 / 0.56mm	I/A handpiece for 2.2mm incisions	45° angled tip		5
M5593	17/24G 	1.47 / 0.56mm	I/A handpiece for 2.2mm incisions	60° angled tip		5
M5594	17/24G 	1.47 / 0.56mm	I/A handpiece for 2.2mm incisions	90° angled tip		5
M5591	17/24G 	1.47 / 0.56mm	I/A handpiece for 2.2mm incisions	Curved tip		5
M5580	16/21G 	1.6 / 0.81mm	I/A handpiece for 2.7 / 2.8mm incisions	Straight tip		5
M5582	16/21G 	1.6 / 0.81mm	I/A handpiece for 2.7 / 2.8mm incisions	45° angled tip		5
M5583	16/21G 	1.6 / 0.81mm	I/A handpiece for 2.7 / 2.8mm incisions	60° angled tip		5
M5584	16/21G 	1.6 / 0.81mm	I/A handpiece for 2.7 / 2.8mm incisions	90° angled tip		5
M5581	16/21G 	1.6 / 0.81mm	I/A handpiece for 2.7 / 2.8mm incisions	Curved tip		5
M5561	21G 	0.81mm	Soft outer I/A handpiece for 2.7 / 2.8mm incisions	45° angled tip		5
M5562	21G 	0.81mm	Soft outer I/A handpiece for 2.7 / 2.8mm incisions	60° angled tip		5
M5563	21G 	0.81mm	Soft outer I/A handpiece for 2.7 / 2.8mm incisions	90° angled tip		5
M5571	24G 	0.56mm	Soft outer I/A handpiece for 2.2mm incisions	45° angled tip		5
M5572	24G 	0.56mm	Soft outer I/A handpiece for 2.2mm incisions	60° angled tip		5
M5573	24G 	0.56mm	Soft outer I/A handpiece for 2.2mm incisions	90° angled tip		5

Irrigating/Aspirating Cannulas and Handpieces

For the aspiration of cortex while simultaneously maintaining the Anterior Chamber with continuous irrigating flow.

Simcoe Irrigating / Aspirating Cannulas





<p>NEW M6613</p>	<p>23 G </p>	<p>23 G / 23 G 0.64 / 0.64mm</p>	<p>I/A Cannula Standard. 200mm silicone tubing. (Simcoe)</p>	<p>0.4mm port. 2.65 OD x 0.65 ID</p>		<p>BOX 10</p>
<p>NEW M6614</p>	<p>23 G </p>	<p>23 G / 23 G 0.64 / 0.64mm</p>	<p>I/A Cannula Standard. 270mm silicone tubing. (Simcoe)</p>	<p>0.4mm port. 2.65 OD x 0.65 ID</p>		<p>10</p>
<p>NEW M6617</p>	<p>23 G </p>	<p>23 G / 23 G 0.64 / 0.64mm</p>	<p>I/A Cannula Standard. 200mm silicone tubing. (Simcoe)</p>	<p>0.3mm port. 2.0 OD x 1.0 ID</p>		<p>10</p>



















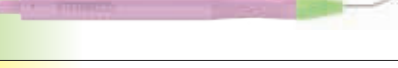











Irrigating/Aspirating Cannulas and Handpieces

For the aspiration of cortex with one handle while simultaneously maintaining the Anterior Chamber with continuous irrigating flow with the other handle.

Bimanual Cannulas



















Code	Gauge	Image	Dimensions	Description	Features	Image	BOX	
							10	100
M6524	21 G		21 G x 5/8" 0.81 x 16mm	Bimanual aspiration cannula. Curved	0.3mm top port		10	100
M5405	21 G		21 G x 5/8" 0.81 x 16mm	Bimanual aspiration cannula. Curved	45° bevelled tip		10	100

Coaxial Handpieces

Code	Gauge	Image	Dimensions	Description	Features	Image	BOX
							5
M5501	23 G		23 G x 5/8" 0.64 x 16mm	Bimanual aspiration handpiece. Curved	0.4mm side port. Micro-etched tip		5
M5502	23 G		23 G x 5/8" 0.64 x 16mm	Bimanual aspiration handpiece. Curved	0.3mm side port. Micro-etched tip		5
M5512	21 G		21 G x 5/8" 0.81 x 16mm	Bimanual aspiration handpiece. Curved	0.3mm side port. Micro-etched tip		5
M5520	21 G		21 G x 5/8" 0.81 x 16mm	Bimanual aspiration handpiece. Curved	0.4mm side port. Micro-etched tip		5
M5511	20 G		20 G x 3/4" 0.9 x 19mm	Bimanual aspiration handpiece. Curved	0.3mm side port. Micro-etched tip		5
M5518	23 G		23 G x 5/8" 0.64 x 16mm	Bimanual aspiration handpiece. Curved	0.3mm side port.		5
M5515	21 G		21 G x 7/8" 0.81 x 22mm	Bimanual aspiration handpiece. Curved	0.3mm side port.		5
M5519	23 G		23 G x 5/8" 0.64 x 16mm	Bimanual irrigation handpiece. Curved	Ultra thin wall. 45° bevelled tip		5
M5505	21 G		21 G x 5/8" 0.81 x 16mm	Bimanual irrigation handpiece. Curved	45° bevelled tip		5
M5513	23 G		23 G x 5/8" 0.64 x 16mm	Bimanual irrigation handpiece. Curved	Thin wall. 2 x 0.4mm side ports		5
M5521	21G		21 G x 5/8" 0.81 x 16mm	Bimanual irrigation handpiece. Curved	Thin wall. 2 x 0.5mm side ports		5
M5514	21G		21 G x 5/8" 0.81 x 16mm	Bimanual irrigation handpiece. Curved	2 x 0.5mm side ports		5
M5510	20G		20 G x 3/4" 0.9 x 19mm	Bimanual irrigation handpiece. Curved	2 x 0.5mm side ports		5
M5523	23G		23 G x 5/8" 0.64 x 16mm	Bimanual irrigation handpiece. Curved	Open end		5

Irrigating/Aspirating Cannulas and Handpieces

For the aspiration of cortex with one handle while simultaneously maintaining the Anterior Chamber with continuous irrigating flow with the other handle.

Bimanual I/A Systems					
M5537 : SET					
	20 G				
	21 G				
Irrigating	20 G x 3/4" 0.9 x 19mm	Bimanual irrigation handpiece. Curved	2 x 0.5mm side ports		BOX
Aspirating	21 G x 7/8" 0.81 x 22mm	Bimanual aspiration handpiece. Curved	0.3mm side port		5 PAIRS
M5531 : SET					
	21 G				
Irrigating	21 G x 5/8" 0.81 x 16mm	Bimanual irrigation handpiece. Curved	Thin wall. 2 x 0.5mm side ports		BOX
Aspirating		Bimanual aspiration handpiece. Curved	0.4mm side port. Micro-etched tip		5 PAIRS
M5331 : SET					
	21 G				
Irrigating	21 G x 5/8" 0.81 x 16mm	Bimanual irrigation handpiece. Curved	2 x 0.4mm side ports. Tapered tip		BOX
Aspirating		Bimanual aspiration handpiece. Curved	0.3mm side port. Micro-etched tapered tip		5 PAIRS
M5535 : SET					
	23 G				
Irrigating	23 G x 5/8" 0.64 x 16mm	Bimanual irrigation handpiece. Curved	Thin wall. 2 x 0.4mm side ports		BOX
Aspirating		Bimanual aspiration handpiece. Curved	0.3mm side port. Micro-etched tip		5 PAIRS
M5536 : SET					
	23 G				
Irrigating	23 G x 5/8" 0.64 x 16mm	Bimanual irrigation handpiece. Curved	Ultra thin wall. 45° bevelled tip		BOX
Aspirating		Bimanual aspiration handpiece. Curved	0.3mm side port		5 PAIRS
M5538 : SET					
	25 G				
Irrigating	25 G x 5/8" 0.5 x 16mm	Bimanual irrigation handpiece. Curved	Ultra thin wall. 45° bevelled tip		BOX
Aspirating		Bimanual aspiration handpiece. Curved	0.3mm side port		5 PAIRS

For more information of other systems available, please contact Sterimedix or your local distributor.

Lachrymal Cannulas



Lachrymal Cannulas





For probing and irrigating the lachrymal ducts.

Part Number	Gauge	Image	Dimensions	Description	Features	BOX	
						10	100
M9275	26 G		26 G x 3/4" 0.45 x 20mm	Lachrymal cannula. Short straight		10	100
M9276	26 G		26 G x 1 1/4" 0.45 x 32mm	Lachrymal cannula. Curved		10	100
M9277	25 G		25 G x 1 1/8" 0.5 x 29mm	Lachrymal cannula. Curved		10	100
M9274	21 G		21 G x 1 1/2" 0.81 x 38mm	Lachrymal cannula. Curved		10	100
M9278	25 G		25 G x 7/8" 0.5 x 22mm	Lachrymal cannula. Straight	0.2mm side port 	10	100
M9272	23 G		23 G x 1/2" 0.64 x 13mm	Lachrymal cannula. Straight	0.3mm side port. Tapered tip 	10	100

Vitreoretinal Products

Trocar Sets

Provides three entry conduits to the posterior segment of the eye, to facilitate the introduction of various micro surgical ophthalmic instruments .











				BOX	
M4510	23 G		23 G	One-step trocar set containing: • 3 x self-sealing valved trocars • 1 x 3.5mm scleral fixation plate • 1 x 185mm BSS infusion	5
M4515	25 G		25 G	One-step trocar set containing: • 3 x self-sealing valved trocars • 1 x 3.5mm scleral fixation plate • 1 x 185mm BSS infusion	5
NEW M4512	23 G		23 G	One-step valved trocar cannula & scleral fixation plate	5
NEW M4517	25 G		25 G	One-step valved trocar cannula & scleral fixation plate	5











Vitreoretinal Products

For specific infusion and aspiration functions during retinal procedures







Vitreoretinal Cannulas

NEW M4486	27 G 	27 G x 1 1/4" 0.4 x 32mm	Aspiration cannula		BOX	
					10	100
M4477	25 G 	25 G x 1 1/4" 0.5 x 32mm	Aspiration cannula		10	100
M4478	23 G 	23 G x 1 1/4" 0.64 x 32mm	Aspiration cannula		10	100
M4478B	23 G 	23 G x 1 1/4" 0.64 x 32mm	Aspiration cannula	Ultra thin wall 	10	100
M4471	20 G 	20 G x 1 1/4" 0.9 x 32mm	Aspiration cannula		10	100

Viscous Fluid Infusion Cannulas

M4453	25 G 	25 G x 1/4" 0.5 x 7mm	Viscous fluid injection cannula		BOX	
					10	100
M4452	23 G 	23 G x 1/4" 0.64 x 8mm	Viscous fluid injection cannula	Bevelled tip 	10	100
M4447	23 G 	23 G x 1/25" 0.64 x 4mm	Viscous fluid injection cannula		10	100
M4448	25 G 	25 G x 1/25" 0.5 x 4mm	Viscous fluid injection cannula		10	100







Dual-Bore Cannulas

M4474	20/25 G 	0.9 / 0.5mm	Perfluorocarbon coaxial (dual bore) cannula		BOX	
					10	100
M4499	23/30 G 	0.64 / 0.3mm	Perfluorocarbon coaxial (dual bore) cannula		10	100
M4499A	25/30 G 	0.5 / 0.3mm	Perfluorocarbon coaxial (dual bore) cannula		10	100







Vitreoretinal Products

For specific infusion and aspiration functions during retinal procedures

Silicone Brush Cannulas

Part Number	Gauge	Image	Dimensions	Tip Type	Silicone Extension	Image	BOX	
							10	100
M4449	25 G		25 G x 1 3/8" 0.5 x 35mm	Silicone brush	Silicone extends 0.7mm beyond end of cannula		10	100
M4459	23 G		23 G x 1 1/4" 0.64 x 32mm	Silicone brush	Silicone extends 0.7mm beyond end of cannula		10	100
M4475	20 G		20 G x 1 1/4" 0.9 x 32mm	Silicone brush	Silicone extends 1.25mm beyond end of cannula		10	100

Soft Tip Cannulas

Part Number	Gauge	Image	Dimensions	Tip Type	Silicone Extension	Image	BOX	
							10	100
M4456	25 G		25 G x 1 1/4" 0.5 x 32mm	Soft tip	Silicone extends 1mm beyond end of cannula		10	100
M4458	23 G		23 G x 1 1/4" 0.64 x 32mm	Soft tip	Silicone extends 2mm beyond end of cannula		10	100
M4457	20 G		20 G x 1 1/4" 0.9 x 32mm	Soft tip	Silicone extends 1mm beyond end of cannula		10	100

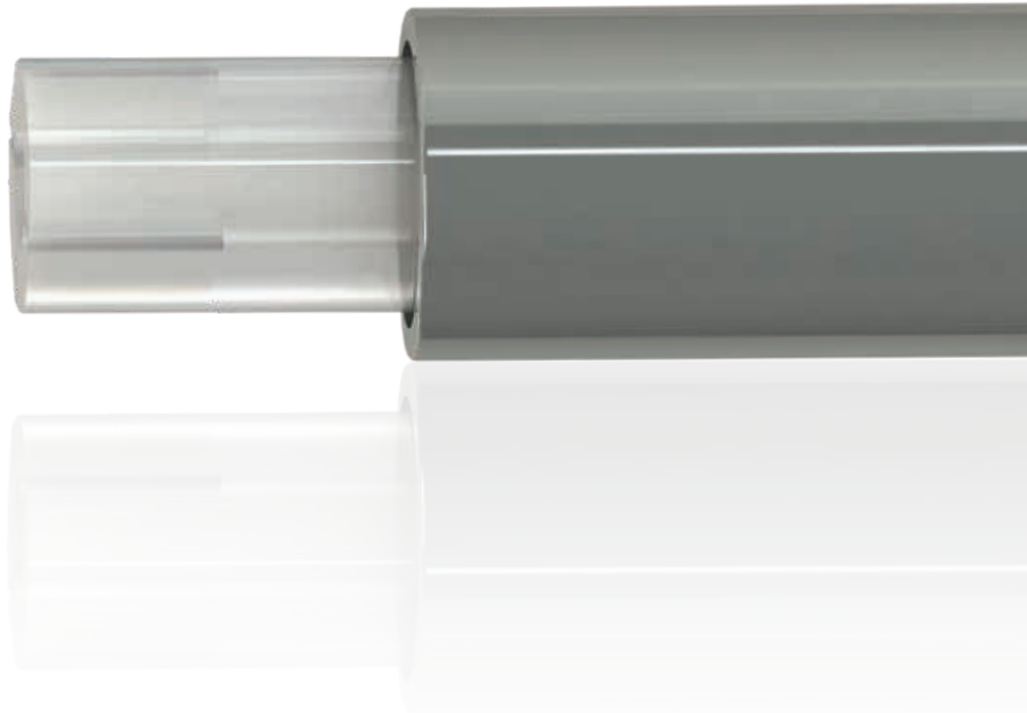

















Vitreoretinal Products

For specific infusion and aspiration functions during retinal procedures

Passive Backflush Handles

M4489		Backflush handle for passive aspiration with finger control and a luer lok cannula connection	BOX
			5











Passive Backflush Handles and Combination Sets

M4503 : SET	25 G 	25 G x 1 1/4" 0.5 x 32mm	Passive backflush handle with 25G soft tip cannula		BOX 5
M4502 : SET	23 G 	23 G x 1 1/4" 0.64 x 32mm	Passive backflush handle with 23G soft tip cannula		5
M4501 : SET	20 G 	20 G x 1 1/4" 0.9 x 32mm	Passive backflush handle with 20G soft tip cannula		5
NEW M4505 : SET	25 G 	25 G x 1 1/4" 0.5 x 32mm	Passive backflush handle with 25G silicone brush cannula		5
M4492 : SET	23 G 	23 G x 1 1/4" 0.64 x 32mm	Passive backflush handle with 23G silicone brush cannula		5
M4500 : SET	25 G 	25 G x 1 1/4" 0.5 x 32mm	Passive backflush handle with 25G aspiration cannula		5
M4497 : SET	23 G 	23 G x 1 1/4" 0.64 x 32mm	Passive backflush handle with 23G aspiration cannula		5
M4496 : SET	20 G 	20 G x 1 1/4" 0.9 x 32mm	Passive backflush handle with 20G aspiration cannula		5

Active / Passive Backflush Handles

M4489A		Active/passive backflush handle with finger control. Allows conversion from active to passive aspiration.	BOX
			5

Active / Passive Backflush Handles and Combination Sets

M4504 : SET	25 G 	25 G x 1 1/4" 0.5 x 32mm	Active/passive backflush handle with 25G soft tip cannula		BOX 5
M4530 : SET	23 G 	23 G x 1 1/4" 0.64 x 32mm	Active/passive backflush handle with 23G soft tip cannula		5
M4531 : SET	20 G 	20 G x 1 1/4" 0.9 x 32mm	Active/passive backflush handle with 20G soft tip cannula		5
NEW M4507 : SET	25 G 	25 G x 1 1/4" 0.5 x 32mm	Active/passive backflush handle with 25G silicone brush cannula		5
NEW M4509 : SET	23 G 	23 G x 1 1/4" 0.64 x 32mm	Active/passive backflush handle with 23G silicone brush cannula		5

Vitreoretinal Products

For specific infusion and aspiration functions during retinal procedures

Vitreoretinal Heavy Liquid Infusion Handles

M4498		Heavy liquid infusion handle with finger control and a luer lok connection	BOX
			5

Charles Flute Handles

M4493		Active/passive backflush handle with finger control. Allows conversion from active to passive aspiration.	BOX
			5

Charles Flute Handles and Combination Sets

M4495 : SET	23 G 	23 G x 1 1/4" 0.64 x 32mm	Charles flute handle with 23G aspiration cannula		BOX
					5



Sterimedix products are packed sterile in a single blister in space saving boxes designed to minimise waste.

Protector for Kit Packers

A new labelled protector for bulk non-sterile products, to provide increased flexibility and reduce packaging waste.

Designed to protect the cannulas and needle tips by ensuring that no distortion or deformation can occur to formed or angled products such as cystotomes.

For further information, please contact us at: sales@sterimedix.



www.sterimedix.com

PRODUCT CODE	SIZE	DESCRIPTION	PAGE	NO. PER BOX	
M0275	23 G x 1 1/2"	Retrobulbar. Tri-facet	5	10	100
M0278	19 G x 1"	Sub-tenon cannula	5	10	100
M0279	20 G x 1"	Sub-tenon cannula	5	10	100
M0637	25 G x 1 1/2"	Retrobulbar (Atkinson)	5	10	100
M0638	23 G x 1 1/2"	Retrobulbar (Atkinson)	5	10	100
M0641	27 G x 7/8"	Retrobulbar (Atkinson)	5	10	100
M0641A	27 G x 1 1/4"	Retrobulbar (Atkinson)	5	10	100
M0642	25 G x 1 1/4"	Retrobulbar (Atkinson)	5	10	100
M0642A	25 G x 7/8"	Retrobulbar (Atkinson)	5	10	100
M0643	23 G x 1 1/4"	Retrobulbar (Atkinson)	5	10	100
M2270	30 G x 7/8"	Anterior chamber cannula. Angled 35° (Rycroft)	6	10	100
M2270A	30 G x 7/8"	Anterior chamber cannula. Angled 35° (Rycroft)	6	10	100
M2272	26 G x 7/8"	Viscoelastic cannula. Angled 35°	7	10	100
M2273	30 G x 7/8"	Anterior chamber cannula. Angled 35° (Rycroft)	6	10	100
M2273A	27 G x 7/8"	Anterior chamber cannula. Angled 35° (Rycroft)	6	10	100
M2273B	20 G x 7/8"	Anterior chamber cannula. Angled 45° (Rycroft)	6	10	100
M2273C	27 G x 7/8"	Hydrodissector. Curved (Sauter)	10	10	100
M2273D	25 G x 7/8"	Hydrodissector. Curved (Sauter)	10	10	100
M2273E	27 G x 7/8"	Hydrodissector. Curved (Helsinki)	10	10	100
M2273F	25 G x 7/8"	Hydrodissector. Curved (Helsinki)	10	10	100
M2273G	23 G x 7/8"	Anterior chamber cannula. Angled 35° (Rycroft)	6	10	100
M2273H	27 G x 7/8"	Hydrodissector. Curved	10	10	100
M2274	25 G x 7/8"	Hydrodissector. Curved (Kellan)	10	10	100
M2275	25 G x 7/8"	Anterior chamber cannula. Angled 35° (Rycroft)	6	10	100
M2279	27 G x 7/8"	Anterior chamber cannula. Angled 45°	6	10	100
M2280	27 G x 7/8"	Transzonular injection cannula. Angled 33°	6	10	100
M2639	25 G x 1"	Anterior chamber cannula. Angled 35° (Rycroft)	6	10	100
M2639A	25 G x 7/8"	Viscoelastic cannula. Angled 35°	7	10	100
M2642	21 G x 7/8"	Anterior chamber cannula. Angled 35° (Rycroft)	6	10	100
M2657	20 G x 7/8"	Anterior chamber maintainer (Lewicky)	6	10	
M2658	23 G x 9/16"	Anterior chamber maintainer (Lewicky)	6	10	
M2801	25 G x 7/8"	Irrigating lasik cannula. 2 ports (Lin)	4	10	100
M2804	25 G x 7/8"	Irrigating lasik cannula. 6 ports	4	10	100
M2817	27 G x 7/8"	Irrigating lasik cannula. 4 ports	4	10	100
M2822	25 G x 7/8"	Irrigating lasik cannula. 6 ports	4	10	100
M2824	26 G x 7/8"	Irrigating lasik cannula (Slade)	4	10	100
M3000D	25 G x 5/8"	Cystotome. Short curve. Formed	9	10	100
M3000E	27 G x 5/8"	Cystotome. Short curve. Formed	9	10	100
M3000F	27 G x 5/8"	Cystotome. Formed	9	10	100
M3000G	25 G x 5/8"	Cystotome. Formed	9	10	100
M3001 : NEW	27 G x 5/8"	Endocapsular cystotome. Formed (Joyce)	9	10	100
M3602	25 G x 5/8"	Cystotome. Side cutting. Formed	8	10	100
M3610	25 G x 5/8"	Cystotome. Formed	8	10	100
M3610B	27 G x 1 1/2"	Cystotome. Formed	8	10	100
M3610C	25 G x 5/8"	Cystotome. Formed. Angled 35°	8	10	100
M3610S	25 G x 5/8"	Cystotome. Short tip. Formed	8	10	100
M3615	27 G x 7/8"	Long cystotome. Formed	8	10	100
M3626	27 G x 5/8"	Cystotome. Angled	8	10	100
M3626A	25 G x 5/8"	Cystotome. Angled	8	10	100
M3627	25 G x 5/8"	Cystotome. Short curve. Formed	8	10	100
M3627A	27 G x 5/8"	Cystotome. Short curve. Formed	8	10	100

PRODUCT CODE	SIZE	DESCRIPTION	PAGE	NO. PER BOX	
M3629	25 G x 5/8"	Cystotome. Reverse tip. Formed	8	10	100
M3630	30 G x 5/8"	Cystotome. Formed	8	10	100
M3899	25 G x 7/8"	Viscoexpression cannula. Flat tip. Angled (Corydon)	11	10	100
M3899A	25 G x 7/8"	Viscoexpression cannula. Rounded tip. Angled (Corydon)	11	10	100
M3900	25 G x 7/8"	Hydrodissector. Angled. Tapered and flattened tip	10	10	100
M3902	27 G x 7/8"	Hydrodissector. Angled. Tapered and flattened tip	10	10	100
M3904	27 G x 3/4"	Hydrodissector. Angled 90° (Chang)	11	10	100
M3906A	25 G x 7/8"	Hydrodissector. Rounded 'J'-shaped tip	11	10	100
M3907	25 G x 7/8"	Hydrodissector. Angled 45°. Tapered to 0.3mm	11	10	100
M3908	25 G x 7/8"	Hydrodissector. Angled 45°. Tapered to 0.3mm	11	10	100
M3909	23 G x 7/8"	Viscoelastic cannula. Angled 45°	7	10	100
M3910	21 G x 7/8"	Viscoelastic cannula. Straight	7	10	100
M3910A	21 G x 7/8"	Viscoelastic cannula. Angled 45°	7	10	100
M3911	27 G x 7/8"	Hydrodissector. Angled. Flattened tip	11	10	100
M3911A	27 G x 7/8"	Hydrodissector. Angled. Round tip	11	10	100
M3912	23 G x 7/8"	Hydrodissector. Angled 30° (Mackool)	11	10	100
M3914	23 G x 7/8"	Irrigating lasik cannula. Formed. Flattened tip	4	10	100
M3917	27 G x 7/8"	Viscoelastic cannula. Angled. Formed	7	10	100
M3919	27 G x 7/8"	Hydrodissector. Tapered tip (Akahoshi)	10	10	100
M3920 : NEW	27 G x 7/8"	Hydrodissector. Curved. (Frankfurt)	11	10	100
M3921 : NEW	25 G x 7/8"	Hydrodissector. Curved and tapered	11	10	100
M3922 : NEW	27 G x 7/8"	Hydrodissector. Formed	11	10	100
M3926A	27 G x 7/8"	Viscoelastic cannula. Angled 35°	7	10	100
M3927	27 G x 7/8"	Viscoelastic cannula. Angled 25°	7	10	100
M3992	30 G x 7/8"	Hydrodissector. Angled. Flattened tip	10	10	100
M4447	23 G x 1/4"	Viscous fluid injection cannula	20	10	100
M4448	25 G x 1/4"	Viscous fluid injection cannula	20	10	100
M4449	25 G x 1 3/8"	Silicone brush. 0.7mm	21	10	100
M4452	23 G x 1/4"	Viscous fluid injection cannula. Bevelled tip	20	10	100
M4453	25 G x 1/4"	Viscous fluid injection cannula	20	10	100
M4456	25 G x 1 1/4"	Soft tip cannula. 1mm	21	10	100
M4457	20 G x 1 1/4"	Soft tip cannula. 1mm	21	10	100
M4458	23 G x 1 1/4"	Soft tip cannula. 2mm	21	10	100
M4459	23 G x 1 1/4"	Silicone brush. 0.7mm	21	10	100
M4471	20 G x 1 1/4"	Aspiration cannula	20	10	100
M4474	20 G / 25 G	Perfluorocarbon coaxial cannula (dual bore)	20	10	100
M4475	20 G x 1 1/4"	Silicone brush. 1.25mm	21	10	100
M4477	25 G x 1 1/4"	Aspiration cannula	20	10	100
M4478	23 G x 1 1/4"	Aspiration cannula	20	10	100
M4478B	23 G x 1 1/4"	Aspiration cannula. Ultra thin wall	20	10	100
M4486 : NEW	27 G x 1 1/4"	Aspiration cannula	20	10	100
M4489	100mm	Passive backflush handle	22	5	
M4489A	100mm	Active / passive backflush handle	22	5	
M4492 : SET	100mm / 23 G x 1 1/4"	Passive backflush handle + 23 G silicone brush	22	5	
M4493	110mm	Charles flute handle	23	5	
M4495 : SET	110mm / 23 G x 1 1/4"	Charles flute handle + 23 G aspiration cannula	23	5	
M4496 : SET	100mm / 20 G x 1 1/4"	Passive backflush handle + 20 G aspiration cannula	22	5	
M4497 : SET	100mm / 23 G x 1 1/4"	Passive backflush handle + 23 G aspiration cannula	22	5	
M4498	110mm	Heavy liquid infusion handle	23	5	
M4499	23 G / 30 G	Perfluorocarbon coaxial cannula (dual bore)	20	10	100
M4499A	25 G / 30 G	Perfluorocarbon coaxial cannula (dual bore)	20	10	100

PRODUCT CODE	SIZE	DESCRIPTION	PAGE	NO. PER BOX
M4500 : SET	100mm / 25 G x 1¼"	Passive backflush handle + 25 G aspiration cannula	22	5
M4501 : SET	100mm / 20 G x 1¼"	Passive backflush handle + 20 G soft tip cannula	22	5
M4502 : SET	100mm / 23 G x 1¼"	Passive backflush handle + 23 G soft tip cannula	22	5
M4503 : SET	100mm / 25 G x 1¼"	Passive backflush handle + 25 G soft tip cannula	22	5
M4504 : SET	100mm / 25 G x 1¼"	Active / passive backflush handle + 25 G soft tip cannula	22	5
M4505 : SET	100mm / 25 G x 1¼"	Passive backflush handle + 25 G silicone brush	22	5
M4507 : SET	100mm / 25 G x 1¼"	Active / passive backflush handle + 25 G silicone brush	22	5
M4509 : SET	100mm / 23 G x 1¼"	Active / passive backflush handle + 23 G silicone brush	22	5
M4510 : SET	23 G	One-step trocar system	19	5
M4512 : SET	23 G	One-step valved trocar cannula + scleral fixation plate	19	5
M4515 : SET	25 G	One-step trocar system	19	5
M4517 : SET	25 G	One-step valved trocar cannula + scleral fixation plate	19	5
M4530 : SET	100mm / 23 G x 1¼"	Active / passive backflush handle + 23 G silicone brush	22	5
M4531 : SET	100mm / 20 G x 1¼"	Active / passive backflush handle + 20 G silicone brush	22	5
M4619	25 G x 1½"	Irrigating vectis. 5mm. Single port	12	10 100
M4620	25 G x 1½"	Irrigating vectis. 5mm. 2 ports	12	10 100
M5331 : SET	21 G x ⅝"	Bimanual irrigation handpiece. Curved. 2 x 0.4mm side ports. Tapered tip	17	5 PAIRS
	21 G x ⅝"	Bimanual aspiration handpiece. Curved. 0.3mm side port. Micro-etched tapered tip		
M5405	21 G x ⅝"	Bimanual irrigation cannula. Curved. 45° bevelled tip	16	10 100
M5501	23 G x ⅝"	Bimanual aspiration handpiece. Curved. 0.4mm side port. Micro-etched tip	16	5
M5502	23 G x ⅝"	Bimanual aspiration handpiece. Curved. 0.3mm side port. Micro-etched tip	16	5
M5505	21 G x ⅝"	Bimanual irrigation handpiece. Curved. Bevelled tip	16	5
M5510	20 G x ¾"	Bimanual irrigation handpiece. Curved. 2 x 0.5mm side ports	16	5
M5511	20 G x ¾"	Bimanual aspiration handpiece. Curved. 0.3mm side port. Micro-etched tip	16	5
M5512	21 G x ⅝"	Bimanual aspiration handpiece. Curved. 0.3mm side port. Micro-etched tip	16	5
M5513	23 G x ⅝"	Bimanual irrigation handpiece. Thin wall. Curved. 2 x 0.4mm side ports	16	5
M5514	21 G x ⅝"	Bimanual irrigation handpiece. Curved. 2 x 0.5mm side ports	16	5
M5515	21 G x ⅞"	Bimanual aspiration handpiece. Curved. 0.3mm side port	16	5
M5518	23 G x ⅝"	Bimanual aspiration handpiece. Curved. 0.3mm side port	16	5
M5519	23 G x ⅝"	Bimanual irrigation handpiece. Ultra thin wall. Curved. Bevelled tip	16	5
M5520	21 G x ⅝"	Bimanual aspiration handpiece. Curved. 0.4mm side port. Micro-etched tip	16	5
M5521	21 G x ⅝"	Bimanual irrigation handpiece. Thin wall. Curved. 2 x 0.5mm side ports	16	5
M5523	23 G x ⅝"	Bimanual irrigation handpiece. Ultra thin wall. Curved. Open end	16	5
M5531	21 G x ⅝"	Bimanual irrigation handpiece. Thin wall. Curved. 2 x 0.5mm side ports	17	5 PAIRS
	21 G x ⅝"	Bimanual aspiration handpiece. Curved. 0.4mm side port. Micro-etched tip		
M5535	23 G x ⅝"	Bimanual irrigation handpiece. Thin wall. Curved. 2 x 0.4mm side ports	17	5 PAIRS
	23 G x ⅝"	Bimanual aspiration handpiece. Curved. 0.3mm side port. Micro-etched tip		
M5536	23 G x ⅝"	Bimanual irrigation handpiece. Ultra thin wall. Curved. 45° bevelled tip	17	5 PAIRS
	23 G x ⅝"	Bimanual aspiration handpiece. Curved. 0.3mm side port		
M5537	20 G x ¾"	Bimanual irrigation handpiece. Curved. 2 x 0.5mm side ports	17	5 PAIRS
	21 G x ⅝"	Bimanual aspiration handpiece. Curved. 0.3mm side port		
M5538	25 G x ⅝"	Bimanual irrigation handpiece. Ultra thin wall. Curved. 45° bevelled tip	17	5 PAIRS
	25 G x ⅝"	Bimanual aspiration handpiece. Curved. 0.3mm side port		
M5561	21 G	Soft outer I/A handpiece. 45° angled tip	14	5
M5562	21 G	Soft outer I/A handpiece. 60° angled tip	14	5
M5563	21 G	Soft outer I/A handpiece. 90° angled tip	14	5
M5571	24 G	Soft outer I/A handpiece for 2.2mm incision. 45° angled tip	14	5
M5572	24 G	Soft outer I/A handpiece for 2.2mm incision. 60° angled tip	14	5
M5573	24 G	Soft outer I/A handpiece for 2.2mm incision. 90° angled tip	14	5
M5580	16 G / 21 G	I/A handpiece. Straight tip	14	5
M5581	16 G / 21 G	I/A handpiece. Curved tip	14	5
M5582	16 G / 21 G	I/A handpiece. 45° angled tip	14	5

PRODUCT CODE	SIZE	DESCRIPTION	PAGE	NO. PER BOX	
M5583	16 G / 21 G	I/A handpiece. 60° angled tip	14	5	
M5584	16 G / 21 G	I/A handpiece. 90° angled tip	14	5	
M5591	17 G / 24 G	I/A handpiece for 2.2mm incision. Curved tip	14	5	
M5592	17 G / 24 G	I/A handpiece for 2.2mm incision. 45° angled tip	14	5	
M5593	17 G / 24 G	I/A handpiece for 2.2mm incision. 60° angled tip	14	5	
M5594	17 G / 24 G	I/A handpiece for 2.2mm incision. 90° angled tip	14	5	
M6524	21 G x 5/8"	Bimanual aspirating cannula. Curved. 0.3mm top port	16	10	100
M6575	23 G x 5/8"	Cortex extractor. 0.3mm side port	12	10	100
M6575A	23 G x 5/8"	Cortex extractor. 0.4mm side port	12	10	100
M6575B : NEW	23 G x 5/8"	Cortex extractor. Curved. 0.3mm side port	12	10	100
M6576	23 G x 7/8"	Cortex extractor. 0.3mm side port	12	10	100
M6576A	23 G x 1/2"	Cortex extractor. 0.3mm side port	12	10	100
M6594	23 G x 5/8"	Cortex extractor. Bevelled end port (Charleux)	12	10	100
M6595	23 G x 1/2"	Cortex extractor. Bevelled end port (Charleux)	12	10	100
M6596	24 G x 1/2"	Cortex extractor. Bevelled end port (Charleux)	12	10	100
M6611	21 G x 1 1/2"	I/A cannula. Straight	14	10	100
M6613 : NEW	23 G / 23 G	Standard I/A cannula. 0.4mm port. 200mm silicone tubing 2.65 OD x 0.65 ID (Simcoe)	15	10	
M6614 : NEW	23 G / 23 G	Standard I/A cannula. 0.4mm port. 270mm silicone tubing 2.65 OD x 0.65 ID (Simcoe)	15	10	
M6617 : NEW	23 G / 23 G	Standard I/A cannula. 0.3mm port. 200mm silicone tubing 2 OD x 1 ID (Simcoe)	15	10	
M7500	3.5mm / 4.0mm	Scleral marker. 80mm	4	10	
M7510	3.5mm	Scleral fixation / incision template. 75mm	4	10	
M8604	21 G x 1"	Capsule polisher. Angled. 0.3mm side port. Micro-etched tip	13	10	100
M8604A	23 G x 7/8"	Capsule polisher. Angled. 0.3mm side port. Micro-etched tip	13	10	100
M8604B	21 G x 7/8"	Capsule polisher. Angled. 0.3mm side port. Micro-etched tip	13	10	100
M8605	27 G x 7/8"	Silicone tipped polisher. Angled	13	10	100
M8605A	23 G x 7/8"	Silicone tipped polisher. Angled	13	10	100
M8620C	23 G x 1"	Olive tipped polisher. Curved	13	10	100
M8621	23 G x 1"	Olive tipped polisher. Curved. Micro-etched tip	13	10	100
M8622	25 G x 1"	Olive tipped polisher. Angled. Micro-etched tip	13	10	100
M8645	23 G x 7/8"	Capsule scraper. Angled. Micro-etched distal tip	13	10	100
M9272	23 G x 1/2"	Lachrymal cannula. Straight. 0.3mm side port. Tapered tip	18	10	100
M9274	23 G x 1 1/2"	Lachrymal cannula. Curved	18	10	100
M9275	26 G x 3/4"	Lachrymal cannula. Short straight	18	10	100
M9276	26 G x 1 1/4"	Lachrymal cannula. Curved	18	10	100
M9277	25 G x 1 1/8"	Lachrymal cannula. Curved	18	10	100
M9278	25 G x 7/8"	Lachrymal cannula. Straight. 0.2mm side port	18	10	100
M9280	19 G x 1"	Washout cannula. Angled (Bishop Hamon)	6	10	100
M9281	16 G x 1"	Washout cannula. Angled. Flattened tip	6	10	100

Sterimedix[®]
ophthalmic

EXPERTISE

in single-use ophthalmic surgical products



Distributed by:

Sterimedix Limited

Thornhill Road, North Moons Moat, Redditch, Worcestershire B98 9ND, UK
T : +44 (0)1527 501480 F : +44 (0)1527 501491 e : sales@sterimedix.com

www.sterimedix.com

Sterimedix[®] is a registered trademark of Sterimedix Limited © Sterimedix Limited 2019. All rights reserved

Sterimedix policy is one of continuous improvement and we therefore reserve the right to alter specifications and prices without prior notice. All products are sold subject to the company's conditions of sale.