



500 XLE

TREATMENT CHAIR



ENJOY QUALITY AND DESIGN

E

500 XLE

Item No.: 1500 0006

The perfect reclining treatment chair for rotation systems in outpatient operating rooms.

**Powerful
and agile**



MED.TEC at its highest level

Double castors

Four fully rotating double-run castors for back-friendly, easy rolling motion.



Chassis / frame

Precision steel frame chassis, zinc primed with anthracite textured paint coating.

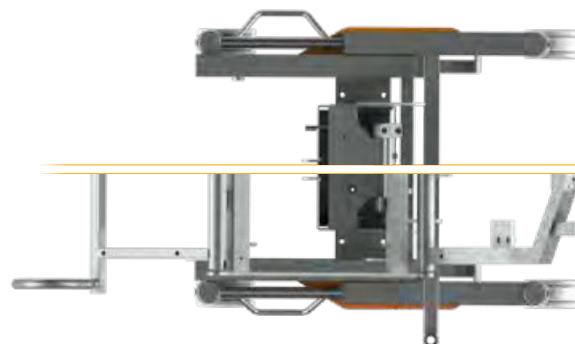

Chassis cover / upholstery

The mirror-finish plastic cover panels with their scratch-resistant and impact-modified surface finish are extremely hygienic and easy to disinfect.

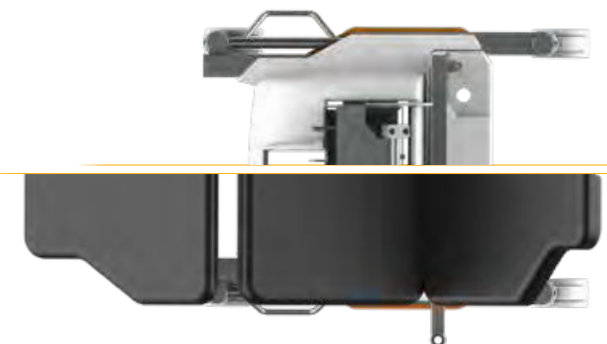

Precise positioning of the head part

Headrest

3D and longitudinally adjustable headrest element with head molding and neck support for guaranteed safe and correct head positioning.

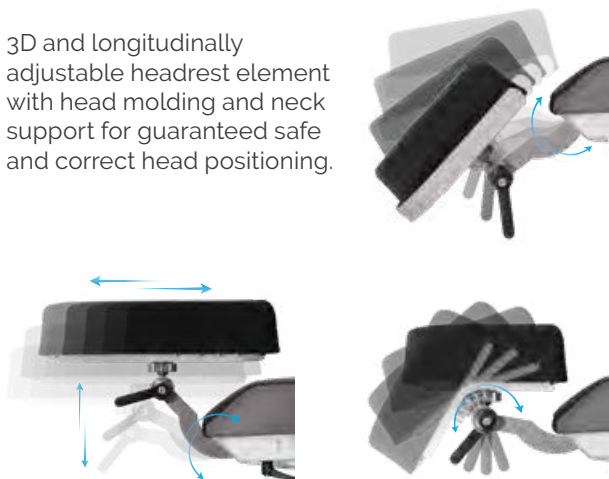

Components

Headrest with ball joint and more

Discover additional features and extensive components on page 34-35.

Item No.: 3351 1021



Sterile adjustment by surgeon / maximum legroom



Flexible reaction by foot control

Removable foot keypad for infinite electronic height and head adjustment including reactivation button from the stand-by mode.



Positioning

The 500 **XLE** treatment chair is designed for ergonomic and comfortable patient positioning and treatment, particularly for outpatient surgical techniques. It offers versatile adjustment of the head, back, seat and leg sections and overall chair height for patient transport.

- Eight freely programmable memory positions
- CPR button
- Reset button
- Auto run function
- Battery charge indicator



Hand control

Multi-functional manual keypad

 Battery charge indicator

 Reset button

 CPR button

 AUTO Auto run function

 MEMORY 8 free configurable memory positions

Positioning by hand control

Standard recommended memo keys



1 Transport



2 Anesthesia



3 Treatment / surgery 1



4 Treatment / surgery 2



5 Flat position

For additional desired Memo positions, the system features 3 additional numeric keys.

Mechanical maneuvering aid on the chassis



Operation via foot lever on the chassis

Activation of directional guidance

Pushing from the head direction



Pushing from the foot direction



Braking system

Manually adjustable foot lever

Castors are braked

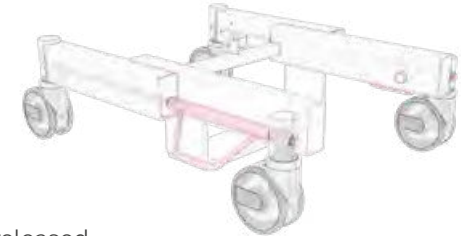

Castors are released, directional guidance is deactivated

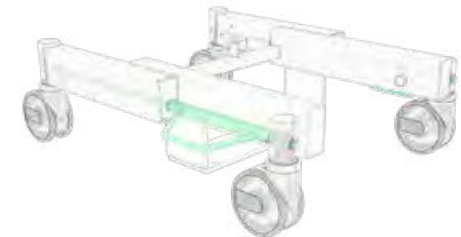

Push handles

Detachable push handles on the foot ends for easy maneuvering.



Armrests

Hinged and removeable armrests for easy entry and exit as well as transfer of the patient.



Components

Additional handles / shoulder parts and more

Discover additional features and extensive components on page 34-35.



500 XLE comfort

Item No.: 1500 0006
+ 3037 0080

Our 500 XLE with extra thick upholstery, integrated knee support cushion and flattened neck area - for extra reclining comfort.

**Outstanding comfort,
particular flexibility.**



Upholstery

Comfort

Thick comfort upholstery and integrated knee support cushion, individually positionable to suit every patient's body height. The treatment chair featuring comfort upholstery is particularly well suited for longer surgical procedures (e.g. retina surgery).



Available in a wide variety of colours. Please refer to page 106 for our complete range of colours.



Flexibility in every detail

Headrest

The flattened back cushion of the Comfort upholstery in the neck area offers maximum freedom of movement for the headrest.

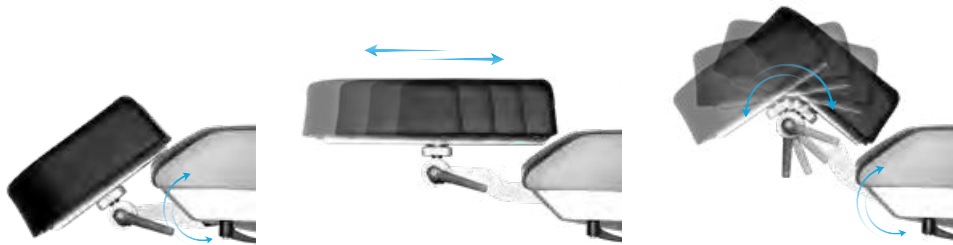

Integrated knee support cushion

Optimum patient comfort thanks to the integrated knee support cushion which can be easily adjusted to accommodate any patient height.



An optional legrest extension can be attached when treating tall or very tall patients.



Components

Foot part extension

Adjustable foot part extension incl. foot support for easier entry and exit of the patient.

Besides, entry height is reduced by 80 mm.

Item No.: 3351 1028



190 mm

Technical specifications



Chassis

- Frame profile 90 x 50 mm
- Outside length 785 mm
- Outside width incl. lever 720 mm
- Steel tube frame, powder-coated elegant anthracite matte finish
- Brake operable from both sides and acting on two castors each; two castors featuring independent directional steering function
- Double rimmed castors \varnothing 125 mm
- Detachable foot keypad (total, head up/down)
- Emergency stop button
- Visible screws are made of stainless steel
- With equipotential bonding connection

Trendelenburg / Reverse Trendelenburg / CPR



Upper frame

- 4-part support frame (head, back, seat, leg part)
- Removeable upholstery
- Width of upholstery 610 mm
- Width incl. armrests 850 mm
- Length 1,760 – 1,900 mm
(incl. legrest extension) + 190 mm

	Angle	Dimensions (L x W)
• Head part	-29° / +35°	255 x 245 mm
• Back part	0° / +83°	610 x 610 mm
• Seat part	-5° / +35°	450 x 610 mm
• Leg part	0° / -77°	510 x 610 mm
• Height adjustment		625 – 925 mm (comfort) 655 – 955 mm
• Armrests	0° / +180°	(2 x) 470 x 75 mm
• Entry height		(standard) 580 mm / 500 mm (incl. legrest extension) (comfort) 610 mm / 530 mm (incl. legrest extension)
• Legroom		520 – 820 mm
• Trendelenburg	-12° / Reverse Trendelenburg +5°	

Back part / Leg part



Electrical control

- All components according to IP54
- Hand control with 8 individually programmable memory positions, auto run function, reset button
- Foot keypad with 4 foot switches and reactivation button

Electric Drives

- Head, back, seat, leg part, total up/down
- Trendelenburg / Reverse Trendelenburg

Lifting column

- Max. lifting 300 mm
- Max. load 250 kg
- Motors IP54 with HAL sensors, to be memorized

Height adjustment

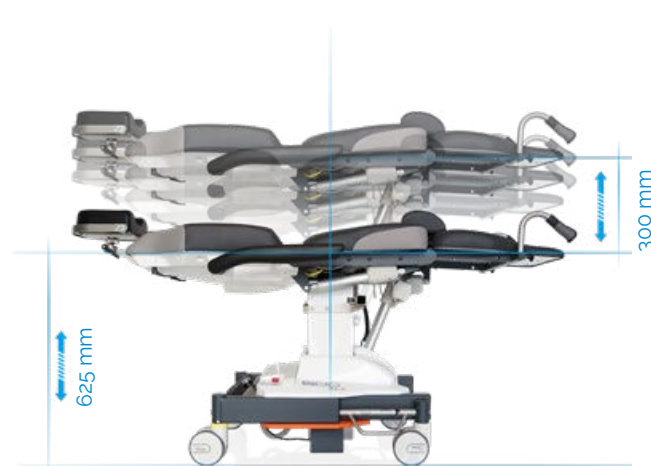

Powerful accumulators

- Battery box with 2 batteries (lead-gel), pollution free, maintenance-free, cadmium-free 2 x 12 V, 7,2 Ah
- As back-up-system exchangeable without tools
- Acoustic low voltage signal for discharge protection
- Universal battery charger Input: 100-240 V Output: 24 V

Operating time per battery charge

- Measured by operating circle (Prepare-Operate-Recover) 100 OPs
- Quantity of operating circles depends on individual operation

Further technical details

- Chair has detachable, swiveling armrests made completely with PUR foam
- Detachable seat for service friendly access to electric components

Max. load 250 kg

Weight 135 kg

Subject to technical modifications.

Mains-free operation

Easy recharging of the equipment thanks to charging adapter and integrated battery charger circuit board.



Equipment protection

Cover drape *stayClean*

2,000 x 730 mm, box á 160 Pieces
4 x 40 Pieces

Item No.: 3034 0014

Page 70



Simple battery replacement

Extra security thanks to exchangeable battery drawer (back-up system **Item No.:** 3047 0000). The rechargeable batteries can be replaced quickly thanks to the rechargeable battery drawer.



Colour card

Standard colour
500 **XL**

anthracite
Item No.: 3037 0052

500 **XLE** *comfort*

anthracite + chrome
Item No.: 3037 0092

"Tundra skai"
Page 108

"Pandoria Plus"
Page 109



Components



PERFORMANCE
LINE



500 XLE
Item No.: 1500 0006



500 XLE comfort
Comfort upholstery incl. integrated knee roll, upcharge
Item No.: 1500 0006 + 3037 0080



Headrest with ball joint, 360° all-round adjustment, factory-fitted

Item No.: 3351 1021



Side parts right and left, swiveling incl. locking, upholstered, 580x200 mm

Item No.: 3351 0012



Norm rail seat part

Item No.: 3351 0047



Side parts right and left, 580x200 mm, incl. quick-release clamp for mounting on norm rail (norm rail 3351 0047 not included)

Item No.: 3351 0050



Backup battery

Item No.: 3047 0000



Pushing handles back part, pair

Item No.: 3351 0046



Pushing handles back part, pair

Item No.: 3351 0017



Anesthesia arm board with universal joint, with arm secure straps

Item No.: 3351 0011



Flexible surgical drape support rod

Item No.: 3205 0000



Flexible surgical drape support rod with air connection

Item No.: 3206 0000



Hand control holder for attachment onto an I.V. Pole Ø 25/18 mm, PVC

Item No.: 3351 1022



Hand control holder, PVC (component holder 3351 0037 not included)

Item No.: 3351 1023



Wrist rest
550x370 mm,
height adjustable,
incl. mounting plate,
adjustment 115 mm

Item No.: 3209 0000



Head part bumper
stainless steel

Item No.: 3028 0000



Wrist rest, adjustable,
incl. mounting plate
3013 0000,
adjustment 115 mm

Item No.: 3014 0000



Wrist rest, adjustable, tiltable,
incl. mounting plate
3013 0000,
adjustment 115 mm

Item No.: 3014 0005



Mounting plate stainless steel,
for wrist rest 3014 0000,
3014 0005 and 3209 0000

Item No.: 3013 0000



Head fixation pillow with
hollow (rubins pillow),
410x250 mm, height 100 mm,
factory-fitted

Item No.: 3022 0000



Facial pillow,
horseshoe-shaped,
incl. adapter plate,
factory-fitted

Item No.: 3351 1016

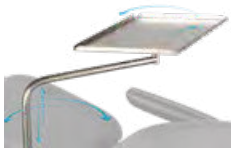

Instrument table
500x300x15 mm, height
adjustable, swiveling,
detachable, incl. adapter
(component holder
3351 0037 not included)

Item No.: 3065 0000



Shoulder parts
right and left
500 XLE
Item No.: 3071 0000

500 XLE comfort
Item No.: 3071 0001



Knee half roll,
600x280x140 mm,
PUD-coated

Item No.: 3019 0000



Knee roll round,
500x150 mm,
PUD-coated

Item No.: 3050 0000



Wrist secure straps,
pair

Item No.: 3015 0000



Body strap with Velcro straps,
2-piece

Item No.: 3083 0000



Foot part extension
incl. foot support,
factory-fitted,
upcharge

Item No.: 3351 1028



Foot protection foil

Item No.: 3092 0001



IV. Pole stainless steel
Ø 25/18 mm,
one-hand height adjustable
1.070–1.660 mm, 4 hooks,
max. 2 kg/hook, glass and
holder (component holder
3351 0037 not included)

Item No.: 3068 0000



Component arm stainless
steel, swiveling,
incl. extendible IV. Pole
Ø 25 mm

Item No.: 3024 0014



Component holder,
stainless steel

Item No.: 3351 0037



Cylinder holder

Item No.: 3072 0002



Instrument table
supportLine
height adjustable 730–985 mm
Item No.: 3351 0026

supportLine plus
height adjustable 930–1.185 mm
Item No.: 3351 0045



Cover drape for
treatment chair,
stayClean
2.000x730 mm,
box à 160 pieces

Item No.: 3034 0014

"Tundra skai"



High quality skai® material with fine calf leather grain and subdued matte-gloss-effect. The very extensive and trend-orientated colour spectrum enables many applications and combinations.

Product Specification

- Long-lasting
- Tear resistant
- Easy to clean
- Abrasion resistant (DIN EN ISO 6570-2)
- Lightfast
- Disinfectant resistant
- Fulfills medical standard (DIN EN ISO 10993-5+10)
- Blood- and urine resistant
- Phthalate-free
- Vegan

<i>eyeForce</i>		1800 0000
<i>500 XLE</i>		1500 0006
<i>500 XLE comfort</i>		1500 0006
		+ 3037 0080
<i>500 bariatric</i>		1500 0002
<i>500 XLS</i>		1500 0005
<i>500 ECO</i>		1500 0008
<i>400 XL</i>		1400 0001
<i>surgiForce</i>	Formed seat	2600 0008
<i>surgiForce light</i>	Formed seat	2600 0009
<i>surgiLine</i>	Formed seat	2200 0008
<i>assistLine</i>		2400 0015
<i>motionLine</i>		1700 0000
<i>motionLine-E</i>		1700 0001

+ Item No.: 3037 0...

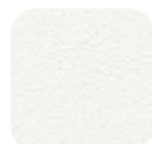

F6461198
Item No.:134

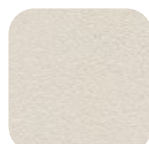

F6461210
Item No.:057

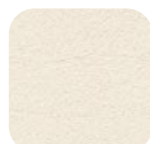

F6461636
Item No.:094



F6461230
Item No.:058



F6461610
Item No.:153



F6461495
Item No.:067



F6461456
Item No.:001



F6461338
Item No.:008

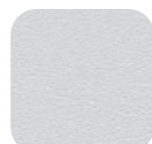

F6461288
Item No.:007



F6461550
Item No.:070



F6461608
Item No.:075



F6461496
Item No.:068



F6461609
Item No.:076



F6461581
Item No.:073



F6461196
Item No.:051



F6461453
Item No.:062



F6461356
Item No.:059



F6461381
Item No.:119



F6461354
Item No.:011



F6461350
Item No.:010



F6461199
Item No.:054



F6461454
Item No.:063



F6461557
Item No.:072



F6461556
Item No.:071



F6461458
Item No.:066



F6461457
Item No.:065



F6461607
Item No.:074



F6461542
Item No.:069



F6461343
Item No.:009



F6461543
Item No.:109



F6461455
Item No.:064



F6461273
Item No.:006



F6461205
Item No.:056



F6461204
Item No.:055



F6461357
Item No.:060



F6461195
Item No.:050



F6461197
Item No.:052

The colours displayed on your device may differ slightly from the original colours. If you wish to receive original colour charts, please contact us at info@ufsk-osys.com.

"Pandoria Plus"



skai® Pandoria Plus is a high-quality upholstery material, whose fine micropore structure gives a certain unobtrusiveness, which is refined by an attractive tone-in-tone effect. The very pleasant feel of the material and the excellent material characteristic and the broad, modern color spectrum make skai® Pandoria Plus universally usable.

Product Specification

- Long-lasting
- Tear resistant
- Easy to clean
- Abrasion resistant (DIN EN ISO 5470-2)
- Resistant to oil and fat
- Lightfast
- Disinfectant resistant
- Flame protection
- Fulfills medical standard
- Resistant to sudor, blood and urine
- 0161-21 (IMO FTPC Part 8)
- Antibacterial according to JIS Z 2801
- Vegan

<i>eyeForce</i>		1800 0000
<i>500 XLE</i>		1500 0006
<i>500 XLE comfort</i>		1500 0006
		+ 3037 0080
<i>500 bariatric</i>		1500 0002
<i>500 XLS</i>		1500 0005
<i>500 ECO</i>		1500 0008
<i>400 XL</i>		1400 0001
<i>surgiForce</i>	Formed seat	2600 0008
<i>surgiForce light</i>	Formed seat	2600 0009
<i>surgiLine</i>	Formed seat	2200 0008
<i>assistLine</i>		2400 0015
<i>motionLine</i>		1700 0000
<i>motionLine-E</i>		1700 0001

+ Item No.: 3037 0136
 + Item No.: 3037 0...

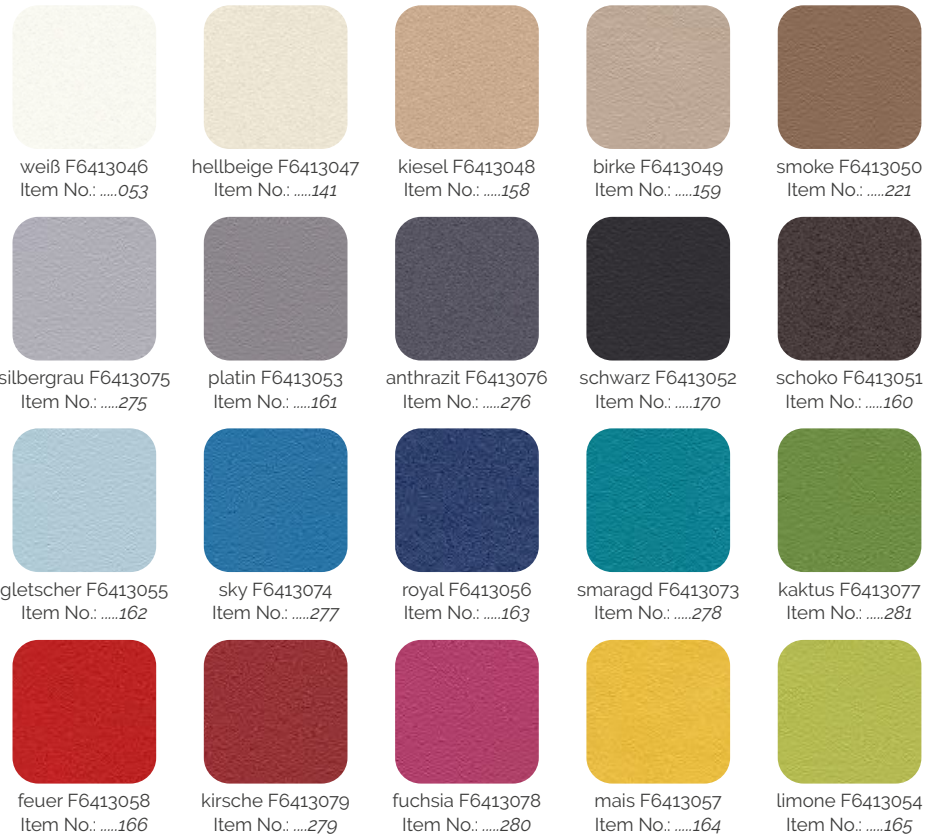

The colours displayed on your device may differ slightly from the original colours. If you wish to receive original colour charts, please contact us at info@ufsk-osys.com.

Upgrade your OR to perfection.



eyeForce



500 XLE



500 XLE comfort



500 bariatric



500 XLS



500 ECO



400 XL



motionLine



motionLine-E



surgiForce



surgiForce light



surgiTrend



surgiLine



stayClean wipes



stayClean



staySoft



stayClean roll



supportLine



supportLine plus



assistTrend



assistPro F



assistPro H



easyPro F



easyPro H



easyPro R



easyLine F



easyLine R



easyLine Rs



assistLine

CONTACT US



UFSK
INTERNATIONAL

OSYS

UFSK-International OSYS GmbH
Kirchhoffstraße 1
93055 Regensburg
Germany

Phone +49 (0) 941 78862 15
Fax +49 (0) 941 78862 35
Mail info@ufsk-osys.com
Web ufsk-osys.com

MADE IN GERMANY
Design | Construction | Manufacturing